

# INSTRUCTION MANUAL

## CONV.ETH

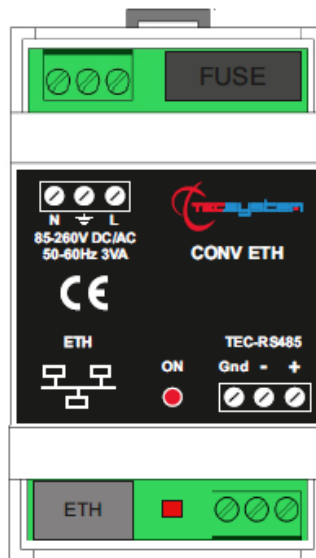

1MN0133REV. 0



operates with ISO9001 certified quality system

**TECSYSTEM S.r.l.**  
20094 Corsico (MI)  
Tel.: +39-024581861  
Fax: +39-0248600783

<http://www.tecsystem.it>

R. 1.0 12/12/16

ENGLISH

“Translations of the original instructions”

## INTRODUCTION

First of all we wish to thank you for choosing to use a **TECSYSTEM** product and recommend you read this instruction manual carefully: You will understand the use of the equipment and therefore be able to take advantage of all its functions.

ATTENTION! THIS MANUAL IS VALID AND COMPLETE FOR THE CONV. ETH

## CONTENTS

	PAGINA
1) SAFETY REQUIREMENTS .....	3
2) ACCESSORIES .....	4
3) TECHNICAL SPECIFICATIONS .....	—
4) FRONT PANEL / CONNECTIONS .....	5
5) MOUNTING .....	—
• POWER SUPPLY .....	—
6) RS485 MODBUS RTU INPUT .....	6
7) OUTPUT ETHERNET MODBUS TCP .....	—
8) ETHERNET MODULE PARAMETERS PROGRAMMING .....	7
• MENU 1 IP PARAMETERS .....	10
• MENU 2 RS485 PARAMETERS .....	11
• LED ETH OUTPUT INDICATIONS PORT .....	12
9) WARRANTY CONDITIONS .....	13
10) TROUBLESHOOTING .....	—
11) EQUIPMENT DISPOSAL .....	—
12) USEFUL CONTACTS .....	—

### PRESENTATION

Thanks to the new CONV ETH Ethernet connectivity enables you to deploy the units Tecsystem functionality in your monitoring system. Allowing you to connect your device, set up with Modbus RTU RS485 output, directly to an Ethernet network.

The CONV ETH includes all the essential network features, including an Ethernet 10BaseT / 100Base-TX, full TCP / IP stack, suitable for work as Modbus TCP slave.

The Web feature can be used for remote configuration of protection limits, real-time monitoring or troubleshooting.

## SAFETY REQUIREMENTS



### ATTENTION :

Carefully read the manual before starting using the device. Keep the instructions for future reference.



Do not open the device, touching any internal component can result in electric shock as voltages over 50 volts can be lethal. In order to reduce the risk of electric shock, do not disassemble the back of the device. Warranty shall be void if device is opened.

**Before connecting the device to the power supply, ensure that all the connections are correct.** Always disconnect the unit from the supply before making any modification on the wiring.



Any operation on the equipment must be operated by a qualified technician.

**Failure to comply with these instructions can cause damages, fires or electric shock, and possible serious injuries!**

#### POWER SUPPLY

The CONV. ETH converter has UNIVERSAL power supply, i.e. it can be supplied from 85 to 260 Vdc-Vac. Before use, ensure that the power cable is not damaged, knotted or pinched. Do not tamper with the power cable. Never disconnect the unit by pulling the cable, avoid touching the clamps. Do not carry out any connecting/disconnecting operation with wet hands. To disconnect the device, do not use objects such as levers. Immediately disconnect the device if you smell burning or see any smoke: contact technical service.

#### LIQUIDS

Do not expose the equipment to liquid spurts or drops, do not position it in places where humidity exceeds 90% and never touch it with wet or humid hands during storms. If any liquid penetrates the converter, disconnect immediately and contact technical service.

#### CLEANING

Disconnect the power cable before cleaning the converter, using a dry cloth without any solvent or detergent, and compressed air.

#### OBJECTS

Never insert objects into the openings of the converter. If this happens, disconnect the converter and contact technical service.

#### USE RESERVED TO QUALIFIED PERSONNEL

The purchased good is an advanced electronic device that should not be used by non-qualified personnel. Any operation must be carried out by a qualified technician.

#### ACCESSORIES

The use of non-original accessories or spare parts may damage the unit and endanger users' safety. In event of fault, contact technical service.

#### LOCATION

Install the converter indoor, in a place protected from water splashes and sun rays. Do not place near heat sources if exceeding the parameters stated in this manual. Position on a stable surface, far from any possible vibrations. Position the unit as far as possible from intense magnetic fields..

#### REPAIRS

Do not open the converter. In case of fault, always contact qualified personnel. The opening of the converter and/or the removal of the series identifying label automatically make the warranty void. The warranty seal is applied to all devices, any attempt to open the unit would cause the seal to break the consequent automatic cancellation of the warranty.

#### TECHNICAL INFORMATION

**Mail:** [ufficiotecnico@tecsystem.it](mailto:ufficiotecnico@tecsystem.it) — **tel:** 02/4581861

## ACCESSORIES

The following objects are present inside the box:

Device CONV. ETH

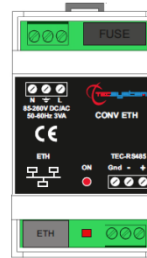

Start guide and QR code

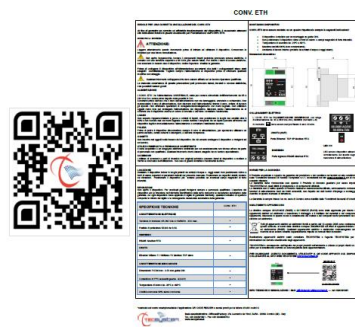

TECHNICAL SPECIFICATIONS	CONV. ETH
<b>ELECTRICAL FEATURES</b>	
Input rated voltage: 85-260 Vac-dc, 50/60Hz, 3VA max	•
Protection fuse 0.5A - 5x20	•
<b>INPUT</b>	
RS485 Modbus RTU	•
<b>OUTPUT</b>	
Ethernet 10Base T / 100Base-TX Modbus TCP slave	•
<b>MECHANICAL FEATURES</b>	
Dimensions: 53x90mm – h.73mm GUIDE DIN	•
UL 94V0 PPO self-extinguishing housing	•
Ambient operating temperature from -20°C to +60°C	•
Humidity 90% no-condensing	•

## FRONT PANEL / CONNECTIONS

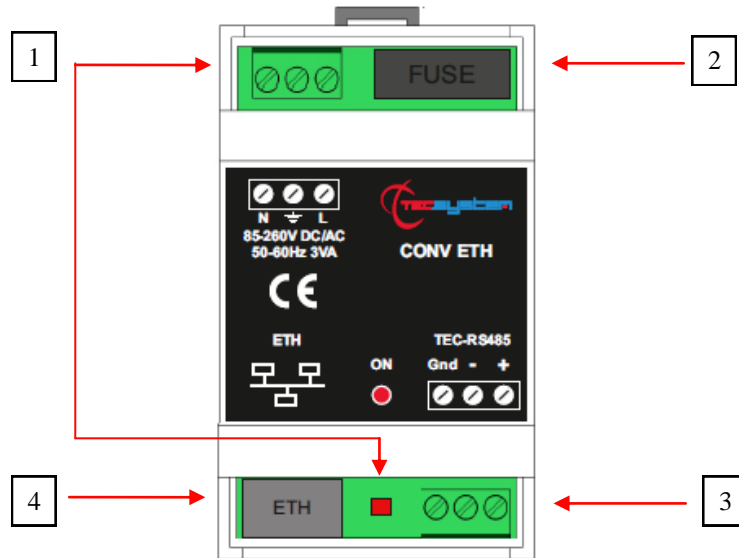

1)	Power supply L-N: 85-260 Vdc-Vac, 50/60Hz, 3VA max LED RED ON = power on	2)	Protection fuse 0.5A - 5x20
3)	RS485 Modbus RTU input	4)	Ethernet 10Base T / 100Base-TX Modbus TCP slave

## MOUNTING

Dimensions: 53X90 mm - h.73 mm mounting using DIN rail.

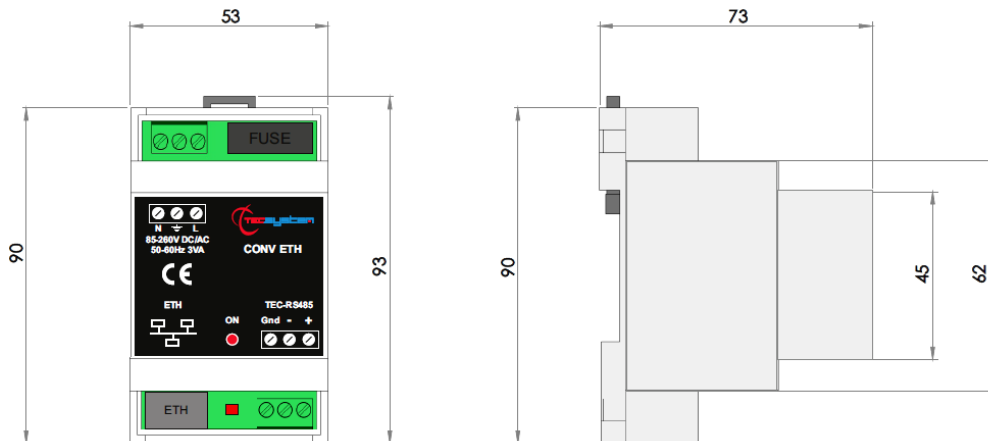

Secure the device on the DIN rail inside the panel.

### POWER SUPPLY

The CONV. ETH has an UNIVERSAL supply, it can be indifferently fed from 85 to 260 Vdc -Vac, 50 / 60Hz (terminals L-N).

The terminal  must always be connected the ground wire.

When the CONV. ETH is supplied directly by the secondary of the transformer, it can be burnt out by strong overvoltages; it is recommended to power the device using auxiliary power supply.

The device is equipped with protection fuse 0.5A - 5x20.

The LED ON (RED)  ON indicates the presence of power, led off not powered device.

## RS485 MODBUS RTU INPUT

### RS485 CONNECTION

Connect the RS485 Modbus RTU output of the temperature monitoring unit directly to the RS485 input of CONV. ETH.

As far as the signal cable to be used in order to ensure the correct network operation is concerned, we recommend you follow the provisions of the EIA RS485 standard which suggests using a 24AWG twisted pair.

Connect the twisted pair paying attention to polarities (+ / -) and lay the network avoiding to make sharp bends or ring windings in order not to modify line impedance. If necessary, the GND terminal for grounding is also available. Always position the RS485 twisted pair far from power cables.

NOTE: The CONV.ETH allows connection to a single RS485 device.

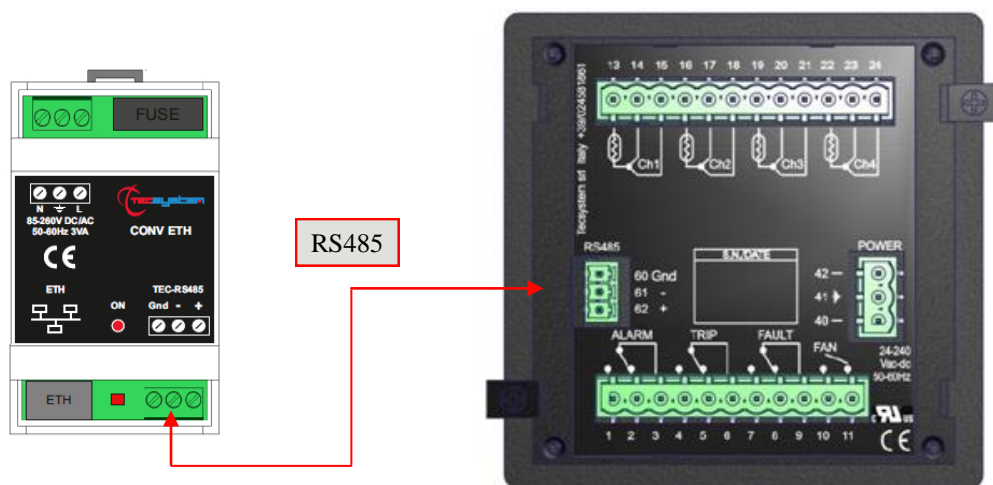

## OUTPUT ETHERNET MODBUS TCP

### INTRODUCTION TO ETHERNET MODULE

The Ethernet connectivity of the CONV. ETH allows you to directly implement the functions of the Tecsystem control units directly into your monitoring system.

The integrated module includes all the essential network features, including an Ethernet 10Base-T / 100Base-TX, full TCP / IP stack, suitable for work as a Modbus TCP slave.

The control unit can be used for remote configuration, real-time monitoring or troubleshooting.

The Telnet-based system allows you to easily configure Windows CONV. ETH

### DATA TRANSMISSION

The Ethernet module allows you to connect to the control unit through Modbus TCP slave so that you can: read / write the data indicated in the mapping table Modbus device, in relation to the Modbus functionality of the connected device. Use the CONV. ETH always in slave mode.

### NOTES ON ETHERNET ELECTRICAL CONNECTIONS

As to the signal cable to use in order to guarantee correct operation, it is necessary to use a CAT 7 Ethernet cable with RJ45 connector with the following specifications:

- 4 twisted pairs 23AWG
- Tinned copper braid with an 80% cover.
- Always position the Ethernet cable far from power cables.

# ETHERNET MODULE PARAMETER PROGRAMMING

X Windows Vista, 7, 8.

## ETH CONNECTIONS

Using an Ethernet cable, connect the RJ45 ETH of the CONV ETH to the ethernet card of a PC.

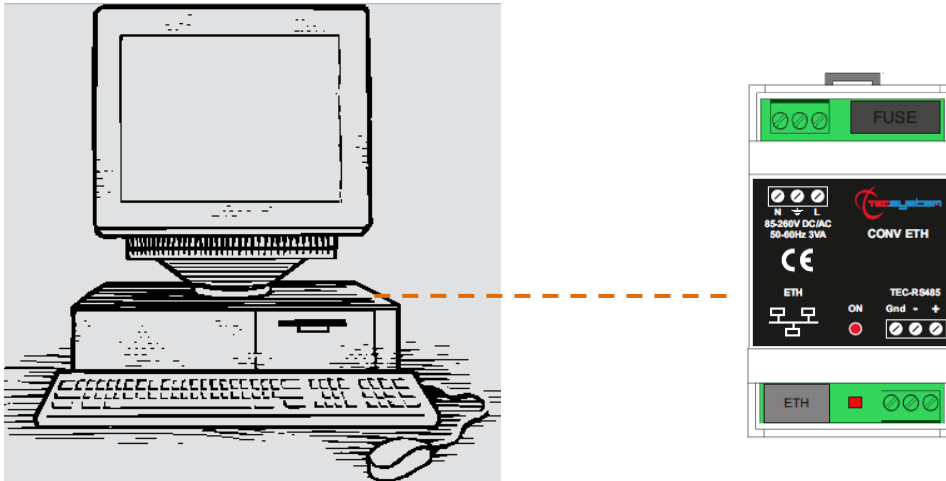

## TELNET ENABLING

Use the Telnet program to set the Ethernet IP parameters.

1) START menu (Windows)

If already enabled, the program appears

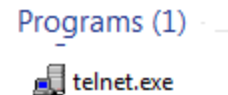

2) Start the search with the Telnet program  
Entering telnet in SEARCH

Press ENTER to launch the program.  
(Go to step 12 on page 8)

If the Telnet program is not enabled:

3) START menu (Windows):

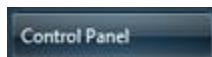

4) Select Control panel

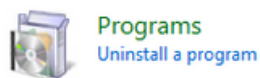

5) Select Programs, followed by Features or Programs and Features

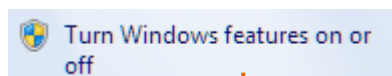

6) Select Turn Windows features on or off

7) Enable Telnet Client and click "OK"

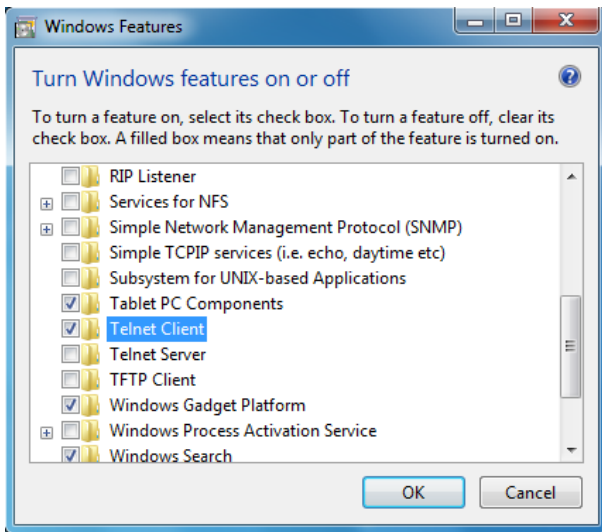

The screen below will open.  
Wait for the Telnet function to activate.

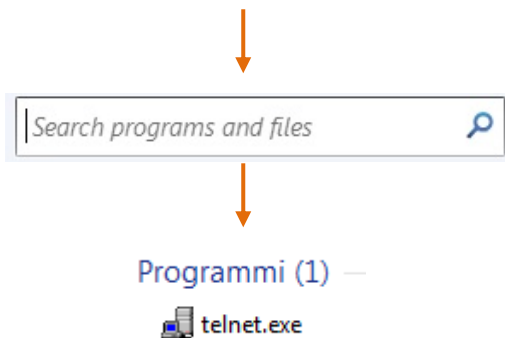
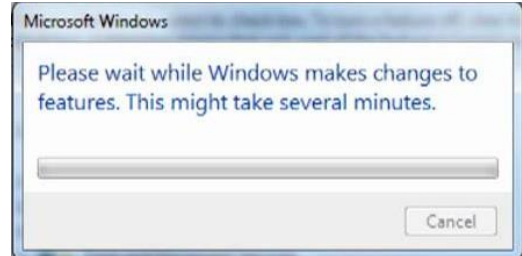

8) Close the open screens and restart the PC if required

9) START menu (Windows)

10) Search for the Telnet program

11) Press ENTER to launch the program

12) TELNET SCREEN

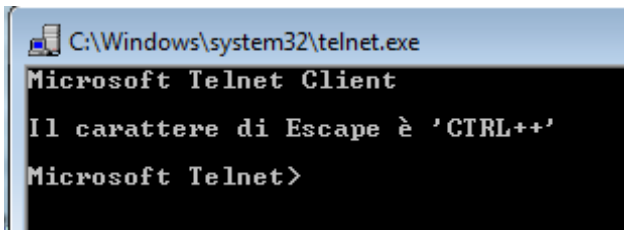

13) Enter: OPEN

14) Press ENTER

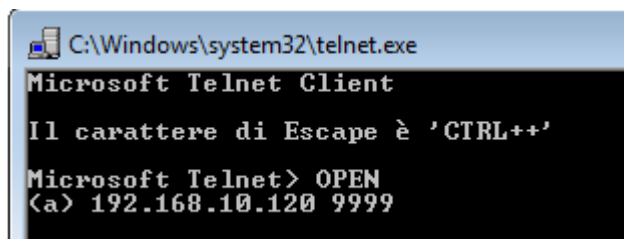

15) Enter: 192.168.10.120 9999

16) Press ENTER

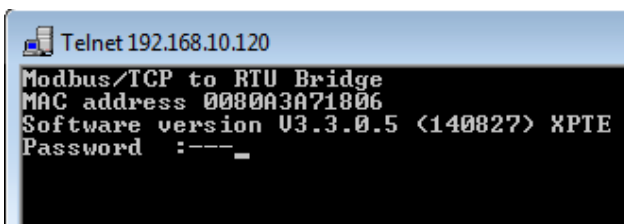

17) Enter the Password: TECS

18) Press ENTER

Note: In this screen we have the **MAC address** and the **software** version of the ETH port available.



## 19) PARAMETERS PROGRAMMING MENU

```
Telnet 192.168.10.120
Modbus/TCP to RTU Bridge
MAC address 0080A3A71806
Software version U3.3.0.5 <140827> XPTC
Password :----
Press Enter for Setup Mode

Model: Device Server Plus+! <Firmware Code:YM>

Modbus/TCP to RTU Bridge Setup
1) Network/IP Settings:
   IP Address ..... 192.168.10.120
   Default Gateway ..... 192.168.10.1
   Netmask ..... 255.255.255.0
   Telnet config password set
2) Serial & Mode Settings:
   Protocol ..... Modbus/RTU,Slave(s) attached
   Serial Interface ..... 19200,8,E,1,RS485
3) Modem/Configurable Pin Settings:
   CP1 ..... RS485 Output Enable
   CP2 ..... Not Used
   CP3 ..... Not Used
4) Advanced Modbus Protocol settings:
   Slave Addr/Unit Id Source .. Modbus/TCP header
   Modbus Serial Broadcasts ... Disabled <Id=0 auto-mapped to 1>
   MB/TCP Exception Codes ..... Yes <return 00AH and 00BH>
   Char. Message Timeout ..... 00050msec, 05000msec
7) Security Settings:
   SNMP ..... Enabled
   SNMP Community Name ..... public
   Telnet Setup ..... Enabled
   TFTP Download ..... Enabled
   Port 77FEh ..... Enabled
   Web Server ..... Enabled
   Enhanced Password ..... Disabled
   Port 77F0h ..... Enabled

D)default settings, S)ave, Q)uit without save
Select Command or parameter set <1..7> to change: _
```

### PARAMETER PROGRAMMING MENU (TELNET)

The TELNET menu allows you to modify the configuration parameters of the Ethernet port.

The information available to you are:

#### Parameters that can be modified by the operator

- 1) Parameter modification (IP Address - Netmask Gateway- -Telnet password).
- 2) RS485 communication parameters (Baud rate - number of bits - Parity -Stop bit)

#### Parameter that cannot be modified by the operator

- 3) Communication configuration ETH port
- 4) Communication advanced settings ETH port
- 7) Security settings ETH port



#### **IMPORTANT WARNING**

For the device to work correctly, we advise you not to access or modify menus 3-4-7. The modification of the values in the stated menus might cause communication anomalies with the loss of the Ethernet IP communication.

## MENU MODIFICATION PROCEDURE MENU 1) IP parameters:

```
Modbus/TCP to RTU Bridge Setup
1) Network/IP Settings:
  IP Address ..... 192.168.10.120
  Default Gateway ..... 192.168.10.1
  Netmask ..... 255.255.255.0
```

enter the command: 1 press ENTER

```
IP Address: IP Address <192> 192.<168> 168.<010> .<120> 120_
```

.1) Enter the desired new IP address, if you wish to keep the set address press ENTER 4 times.

- At the end of the operation, the system will ask if you wish to modify the Gateway IP:

```
IP Address <192> 192.<168> 168.<010> .<120> 120
Set Gateway IP Address <N> ?
```

Enter: Y to modify the Gateway IP.

N not to modify the Gateway IP and go to the following step.

2) Enter the desired new Gateway IP address, press ENTER; if you wish to keep the set address press ENTER 4 times.

```
IP Address <192> 192.<168> 168.<010> .<120> 120
Set Gateway IP Address <N> ? Y
Gateway IP Address : <192> 192.<168> 168.<010> 10.<001> 001_
```

- At the end of the operation, the system will ask if you wish to modify Netmask:

```
IP Address <192> 192.<168> 168.<010> .<120> 120
Set Gateway IP Address <N> ? Y
Gateway IP Address : <192> 192.<168> 168.<010> 10.<001> 001
Set Netmask <N for default> <N> ?
```

Enter: Y to modify Netmask.

N not to modify Netmask and go to the following step.

3) Enter the new Netmask, press ENTER; if you wish to keep the set address press ENTER 4 times.

```
IP Address <192> 192.<168> 168.<010> .<120> 120
Set Gateway IP Address <N> ? Y
Gateway IP Address : <192> 192.<168> 168.<010> 10.<001> 001
Set Netmask <N for default> <N> ? Y
<255> .<255> .<255> .<000> _
```

- At the end of the operation, the system will ask if you wish to modify the Telnet Password:

```
IP Address <192> 192.<168> 168.<010> .<120> 120
Set Gateway IP Address <N> ? Y
Gateway IP Address : <192> 192.<168> 168.<010> 10.<001> 001
Set Netmask <N for default> <N> ? Y
<255> .<255> .<255> .<000>
Change telnet config password <N> ? _
```

Enter: **Y** to modify the Telnet Password.

**N** not to modify the Telnet Password and go to the following step.

```
IP Address (192) 192.(168) 168.(010) .(120) 120
Set Gateway IP Address (N) ? Y
Gateway IP Address : (192) 192.(168) 168.(010) 10.(001) 001
Set Netmask (N for default) (N) ? Y
(255) .(255) .(255) .(000)
Change telnet config password (N) ? Y
Enter new Password:
```

4) Enter the new Telnet Password (4 digits max), press ENTER; if you wish to keep the set Password, press ENTER.

```
D)default settings, S)ave, Q)uit without save
Select Command or parameter set (1..?) to change: _
```

Enter: **S** to save the modified data.

**Q** to exit Telnet without saving the data.

The following screen will be displayed:

```
D)default settings, S)ave, Q)uit without save
Select Command or parameter set (1..?) to change:
→ Parameters saved, Restarting ...

Connessione all'host perduta.
Premere un tasto per continuare..._
```

To check the programmed parameters or repeat programming, follow the TELNET SCREEN from step 12 to step 19, page 8.

## MENU MODIFICATION PROCEDURE MENU 2) RS485 parameters:

```
2) Serial & Mode Settings:
Protocol ..... Modbus/RTU,Slave(s) attached
Serial Interface ..... 19200,8,E,1,RS485
```

Type the command: **2** - Press enter

Device configuration as slave **Attached Device (1=Slave 2=Master) (1) ?** \_

1) Type **1** and press ENTER to configure the device as slave.

Configuration Modbus RTU communication protocol.

```
Attached Device (1=Slave 2=Master) (1) ? 1
Serial Protocol (1=Modbus/RTU 2=Modbus/ASCII) (1) ?
```

2) Type **1** and press ENTER to configure the device as Modbus RTU.

Configuration 2-wire RS485 connection.

```
Attached Device (1=Slave 2=Master) (1) ? 1
Serial Protocol (1=Modbus/RTU 2=Modbus/ASCII) (1) ? 1
Interface Type (1=RS232 2=RS422/RS485+4-wire 3=RS485+2-wire) (3) ? _
```

3) Type **3**, and then press ENTER to configure the device as a 2 wire RS485.

### Configuring the RS485 communication parameters (Serial)

```
Attached Device <1=Slave 2=Master> <1> ?  
Serial Protocol <1=Modbus/RTU 2=Modbus/ASCII> <1> ?  
Interface Type <1=RS232 2=RS422/RS485+4-wire 3=RS485+2-wire> <3> ?  
Enter serial parameters <19200,8,E,1> 19200,8,E,1_
```

3) Type the serial communication parameters:

**Default RS485: Baud rate (19200), number of bits (8), Parity (E), Stop bit (1).**

Configurable parameters with Tecsystem units (\*):

Baud rate: 2400-4800-9600-19200-38400

Bit number: 8

Parity: N =NONE O = ODD - E = EVEN

Stop bit: 1 or 2

(\*) See device manual to verify compatibility parameters.

Press ENTER.

```
D>default settings, S>ave, Q>uit without save  
Select Command or parameter set <1..7> to change: _
```

Enter: S to save the modified data.

Q to exit Telnet without saving the data.

```
D>default settings, S>ave, Q>uit without save  
Select Command or parameter set <1..7> to change:  
Parameters saved, Restarting ...  
Connessione all'host perduta.  
Premere un tasto per continuare..._
```

To check the programmed parameters or repeat programming, follow the TELNET SCREEN from step 12 to step 19, page 8.

**NOTE: CONV. ETH is forced with ADDRESS device 1; it will therefore be necessary to set the RS485 device with ADDRESS 1.**

### LED ETH PORT INDICATIONS

Indications of LEDs 1-2 of the Ethernet port :

led 1: Link

- > Off = No link
- > Amber = 10 Mbps
- > Green = 100 Mbps

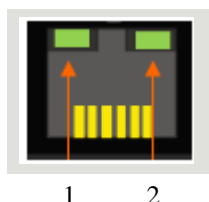

led 2: Activity

- > Off = No Activity
- > Amber = Half Duplex
- > Green = Full Duplex

## WARRANTY CONDITIONS

The Product purchased is covered by the manufacturer's or seller's warranty at the terms and conditions set forth in the "Tecsystem s.r.l.'s General Conditions of Sale", available at [www.tecsystem.it](http://www.tecsystem.it) and / or purchase agreement.

The warranty is considered valid only when the product is damaged by causes attributable to TECSYSTEM srl, such as manufacturing or components defects.

The warranty is invalid if the Product proves to have been tampered with / modified or incorrectly connected and causing voltages outside the set limits and does not comply with the technical data for use and assembly, as described in this instruction manual.

The warranty is always ex Corsico as stated in the "General Conditions of Sale".

TROUBLESHOOTING	CAUSES AND SOLUTIONS
The ON LED does not light and power to the L-N heads of terminals is correct.	Disconnect the power supply and check that: L-N cables are tight, there are no obvious signs of burns on terminals L-N
The LED of the ETH port are off or amber.	Check the ETH port connection.
The device does not communicate with the data acquisition system.	Check the RS485 parameters set on the control unit and in the Menu 2 of the ETH port RS485 - RS485 Default: Baud rate (9600), number of bits (8), Parity (N), Stop bits (1) Address (1), page 11.
The device does not communicate with the data acquisition system.	Check the IP parameters in Menu 1 RS485 port ETH - Default IP: 192.168.10.120 - Gateway: 192.168.10.1 Netmask: 255.255.255.0. page 10.
Contact <i>TECSYSTEM Technical Department</i> if the problem persists.	

## EQUIPMENT DISPOSAL

European directives 2012/19/EC (WEEE) and 2011/65/EC (RoHS) have been approved to reduce electrical and electronic waste and promote the recycling and reuse of the materials and components of said equipment, cutting down on the disposal of the residues and harmful components of electrical and electronic materials.



All the electrical and electronic equipment supplied after 13 August 2005 is marked with this symbol, pursuant to European directive 2002/96/EEC on electrical and electronic waste (WEEE). Any electrical or electronic equipment marked with this symbol must be disposed of separately from normal domestic waste.

Returning used electrical devices: contact TECSYSTEM or your TECSYSTEM agent for information on the correct disposal of the devices.

TECSYSTEM is aware of the impact its products have on the environment and asks its customers active support in the correct and environmentally-friendly disposal of its devices.

## USEFUL CONTACTS

TECHNICAL INFORMATION : [ufficiotecnico@tecsystem.it](mailto:ufficiotecnico@tecsystem.it)

SALES INFORMATION : [info@tecsystem.it](mailto:info@tecsystem.it)

